

**WESTCHESTER**  
**owner's manual**

# warranty

The Westchester Tractor and attachments are warranted to be free from defective materials and workmanship for a period of ninety (90) days from the date of delivery. All defective parts will be replaced free of charge, provided such parts are returned to the Seller, shipping charges prepaid, and in the judgment of the Seller, after inspection, are defective, and have

not been damaged in shipping or by accident or misuse.

This Warranty is not valid or effective unless within seven (7) days after delivery you complete the Warranty Registration Card, accompanying your Tractor, and mail it to the Manufacturer at the address shown below.

***GRAVELY***



TRACTOR DIVISION  
**Studebaker**  
CORPORATION

Gravelly Lane, Dunbar, West Virginia 25064

# about your owner's manual

The Westchester Owner's Manual is intended as a guide to operation and normal care and maintenance of the Westchester Tractor and attachments. It is not intended to be a comprehensive service manual.

It is divided into four main sections:

► The Westchester Tractor (Page 4)

► Westchester Accessories (Page 28)

► Westchester Power Attachments (Page 30)

► Westchester Non-Power Attachments (Page 48)

The Manual's loose-leaf design will permit you to keep up-to-date instructions always on hand. As you purchase additional attachments, your Gravelly dealer will provide you instruction sheets which you can insert in your Manual.

# the WESTCHESTER tractor

The Westchester Tractor, by Gravely, brings to you ultimate care for your lawn and grounds. To get the most from your Westchester and its year-round tools, we suggest you read this manual carefully before operating your equipment.

## SPECIFICATIONS

### • ENGINE

**Manufacturer:** Gravely

**Type:** One-cylinder, air-cooled, four-cycle, overhead valves

**Horsepower:** 12 rated

**Bore:** 3¼ inches

**Stroke:** 3½ inches

**Displacement:** 29.03 cubic inches

**Compression Ratio:** 6.3:1

**Cam Shaft:** Proferall cast iron

**Crankcase:** Aluminum

**Piston:** Aluminum

**Connecting Rod:** Forged steel

**Rings:** Two compression, one three-piece oil

**Valves:** Alloy steel; Stellite face on Exhaust Valve; Stellite exhaust Valve Seat Insert; Ni-resist Intake Valve Seat Insert

**Engine Head:** Aluminum

**Lubrication:** Pressure lubrication to Crank Shaft and Connecting Rod; pressure-fed lubrication to Valves and Rocker Arms; splash lubrication to Cam Shaft and Piston

**Ignition:** Distributor ignition, automatic spark advance, 12-volt Starter-Generator controlled by key ignition switch

**Air Cleaner:** Dry type

**Governor:** Centrifugal type, belt-driven

**Carburetor:** Carter, one-inch side draft

### • TRANSMISSION

**Differential:** Hardened-steel-cut Bevel Gears, steel Worm, special alloyed bronze Worm Gear hardened steel two-speed Axle

**Clutches:** Two double-acting cone type; one for forward and reverse, one for high and low, with special bonded lining to grey iron casting

**Bearings:** Tapered roller or ball bearings at all important points

**Lubrication:** Splash lubricated from same oil supply as Engine

### • GENERAL

**Overall Length:** 74¾ inches

**Overall Width:** 32 inches

**Wheel Base:** 48¾ inches

**Height over Steering Wheel:** 37¾ inches

**Height to Top of Hood:** 35 inches

**Tire Size:** 4:00 x 8 on wide-base Rim

**Shipping Weight:** 900 pounds

**Body:** Fiber-reinforced plastic

## fuel

Use a good regular gasoline, not high-test. We recommend Mobil Regular. Fuel Tank capacity is 2 1/2 gallons, but to allow for expansion, do not fill the Tank completely. The Fuel Tank Cap is under the Seat, which can be tilted forward for clear access to the Cap.

## lubrication

Filling the Transmission Case to capacity with motor oil lubricates both the Engine and Transmission. We recommend these oils or equivalents:

Above 32° F.--Mobiloil A (SAE 30) or Mobiloil Special (SAE 10W-30).

Below 32° F.--Mobiloil Arctic (SAE 20) or Mobil Special (SAE 10W-30).

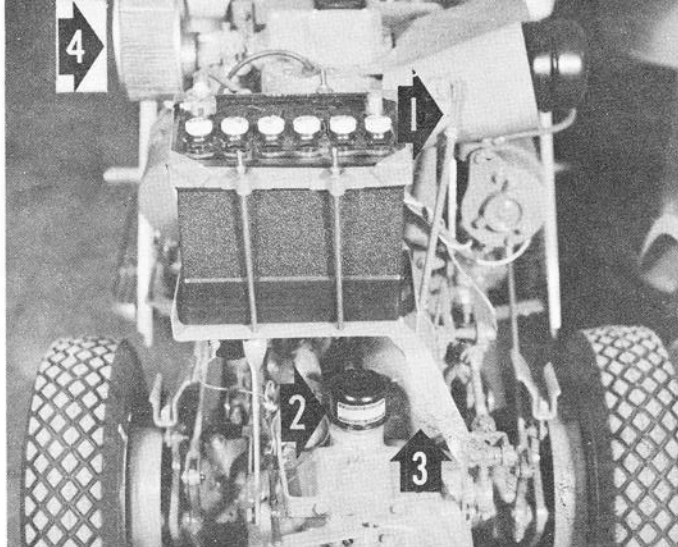

1

1. Dipstick
2. Oil Filler Cap
3. Oil Filter
4. Air Cleaner

Below 0° F.--Mobiloil Arctic (SAE 10).

SEE  
FIGURE

1

**OIL LEVEL.** Routinely check the oil level with the Dipstick. Be sure the Tractor is level and the Engine is not running.

**ADDING OIL.** Add oil by removing the Oil Filler Cap. Stop

when oil reaches the **FULL** mark on the Dipstick. However, allow the oil to circulate for a couple of minutes before checking the oil level. This prevents over-filling the Transmission Case.

Inspect the Cap periodically for cleanliness, and wash it in a solvent when required.

**OIL CHANGES.** During the break-in period (the first 40 hours of Engine operation), change oil every 20 hours. After this, change oil every 60 hours under normal conditions, and more frequently under extremely dusty or dirty conditions or during extended operation.

The Transmission Case oil capacity is five pints. However, if the Oil Filter is changed at the

SEE  
FIGURE  
1

SEE  
FIGURE  
2

SEE  
FIGURE  
1

same time, extra oil must be added to fill the Filter.

Drain used oil from the Transmission Case by removing the Oil Drain Plug, the bottom bolt in the left Axle Housing. Be sure the special sealing washer is in place on the Plug before reinserting in the Axle Housing.

**OIL FILTER.** Actual operating conditions will govern the frequency of Oil Filter changes. As a general guide change the Filter every 80 hours of operation. However, the Filter may perform satisfactorily up to 150 hours--again depending on the actual operating conditions.

Note the cleanliness of the oil whenever you check the oil level. As long as the oil remains clean there is no reason to change the Filter. However, should the oil

2

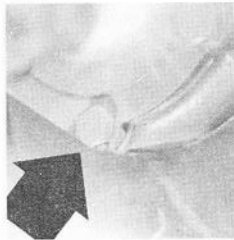

3

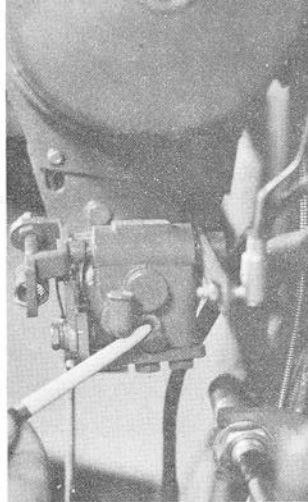

appear black, especially within a few hours of an oil change, a new Filter is indicated.

The Filter is designed to be unscrewed by hand, but occasionally it may be necessary to use slight force to free it.

When attaching a new Filter, do not over-tighten it, as this could damage its seals. Also, do

not change the connections in any way when replacing the Filter.

**OIL PRESSURE.** When the Engine is started, the Oil Pressure Light (on the dashboard) will come on, but will go off within 10 seconds if oil pressure is correct.

If the Light stays on longer than 10 seconds, stop the engine immediately and check the oil level. Add oil if required and start the Engine again.

Then if the Light stays on longer than 10 seconds, stop the Engine and call your Gravelly dealer. Do not start the Engine until it has been checked by your Gravelly dealer.

SEE  
FIGURE  
3

**GOVERNOR.** Routinely check the Governor oil level by removing the Oil Level Screw. Add oil (the same kind as you are using in



the Transmission Case) through the Oil Filler Pipe.

**HYDRAULIC PUMP.** Routinely check the Hydraulic Pump fluid level by removing the Fluid Filler Plug. Add fluid until even with the lower lip of the Plug Hole. Be sure the Tractor is level when checking the fluid level or adding fluid. We recommend Mobilfluid 200 (Type A automatic transmission fluid).

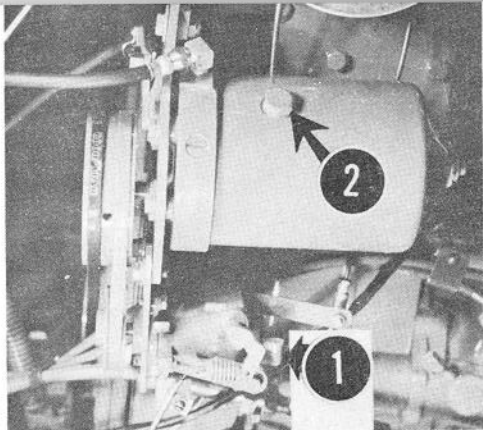

1. Oil Filler Pipe
2. Fluid Filler Plug

**GREASE FITTINGS.** Use Mobilgrease MP, or similar high quality lubricant, in the grease fittings shown below:

Steering column--once a year;

Steering Bell Crank } Rear Axle

Pivot, Left Rear Axle, Right Rear Axle--every 50 hours.

**OTHER LUBRICATION.** Pack the Rear Wheels and Steering Drag Linkage annually with Mo-

SEE FIGURES

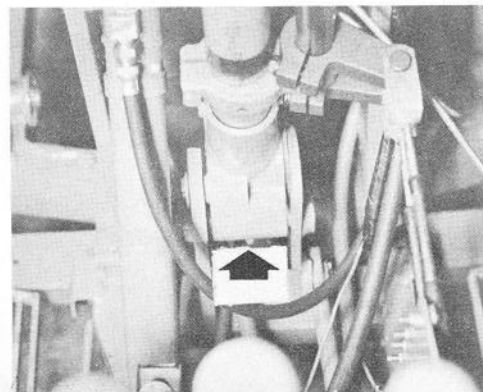



bilgrease MP or similar high quality lubricant.

Occasionally use light machine oil on the Clutch Rod Sleeves, Two-Speed Axle Linkage, Brake Pedals, and in the Distributor.

SEE  
FIGURES

- 7
1. Rear Axle Pivot
  2. Left Rear Axle
  3. Right Rear Axle
  4. Steering Drag Linkage

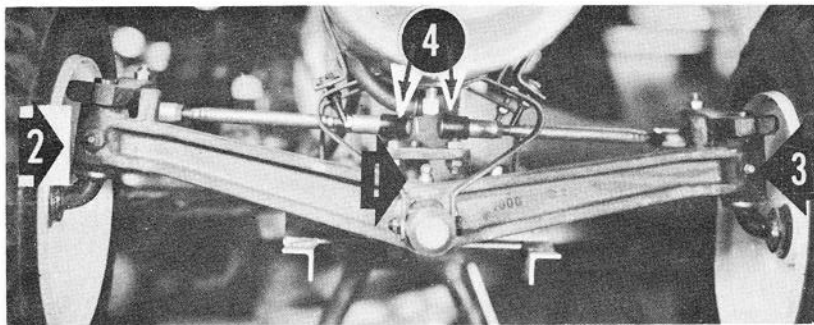
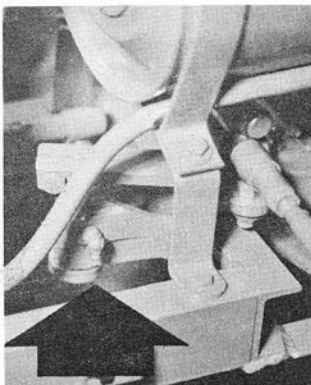
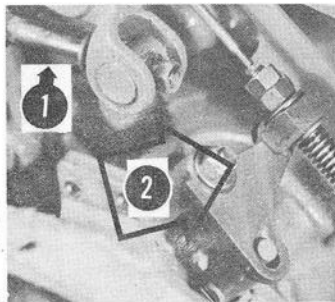

9



8

1. Clutch Rod Sleeve
2. Two-Speed Axle Linkage

## air cleaner

The Tractor has a dry-type Air Cleaner. Periodically remove the Air Cleaner (by removing the two screws on its face) and clean by shaking vigorously and then washing in a solvent. Do not rap, strike, or otherwise treat the Air Cleaner in a manner that could puncture it.

After allowing the solvent to drain completely, saturate the Air Cleaner in the same type of oil that is being used in the Transmission Case. Allow excess oil to drain before replacing the Air Cleaner on the Tractor.

When replacing, be sure the Air Cleaner rests snugly against the seal between it and the Carburetor.

Do not run the Engine with the

SEE  
FIGURE  
1

Air Cleaner disconnected. To do so will introduce dirt and dust into the Engine, scoring the Cylinder, and making necessary a major repair job.

## battery

Periodically inspect the level of Battery fluid. When required, fill to the split-ring in each of the six cells with distilled water.

## controls

SEE  
FIGURE  
10

All Tractor controls are grouped within easy reach of the operator in a console.

**THROTTLE LEVER.** The Throttle Lever controls the amount of fuel fed to the Engine.

**CHOKE LEVER.** The Choke Lever controls the amount of air reaching the Engine.

**HIGH-LOW LEVER.** The High-Low Lever shifts the Transmission between high and low speeds.

**FORWARD-REVERSE LEVER.** The Forward-Reverse Lever shifts the Transmission between forward and reverse.

**SWIFTAMATIC LEVER.** The Swiftamatic Lever shifts the Two-Speed Axle between high and low ranges.

**ATTACHMENT CLUTCH LEVER.** The lower lever on the Steering Column, the Attachment Clutch Lever engages and disengages front-mounted power attachments. Push the Lever forward to engage Engine power to the attachment; pull it to the rear to disengage Engine power from the attachment.

**ATTACHMENT LIFT LEVER.** The Attachment Lift Lever, the

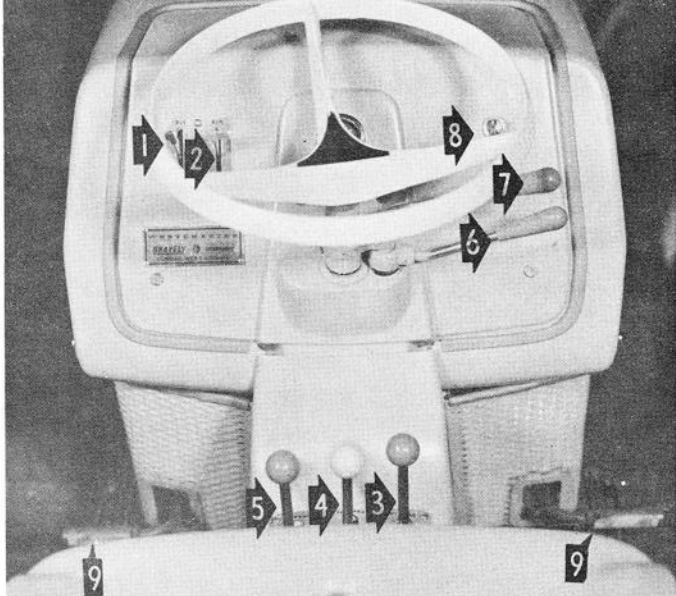

10

1. Throttle Lever
2. Choke Lever
3. High-Low Lever
4. Forward-Reverse Lever
5. Swiftamatic Lever
6. Attachment Clutch Lever
7. Attachment Lift Lever
8. Ignition Key
9. Brake Pedals

upper lever on the Steering Column, controls the Hydraulic Attachment Lift. Push the Lever

forward to lift the attachment; pull it to the rear to lower the attachment to operating position.

**IGNITION KEY.** Turn the Ignition Key clockwise fully to start the Engine. Then release the Key to permit it to return automatically to the running position. To stop the Engine, turn the Key counter-clockwise from the running position to the off position (the slot points straight up and down in the off position).

**FUEL GAUGE.** The Fuel Gauge shows the amount of fuel remaining in the Fuel Tank.

**OIL PRESSURE LIGHT.** When the Engine is started, the Oil Pressure Light comes on, but goes off within 10 seconds if oil pressure is correct. Any time the Light comes on while the Engine is running, stop the Engine imme-

diately and check the oil level, adding oil if required. Then start the Engine again. If the Light stays on past 10 seconds, stop the Engine and call your Gravelly dealer right away. Do not start the Engine until it has been checked by your Gravelly dealer.

**GENERATOR LIGHT.** The Generator Light comes on when the Engine is started, but like the Oil Pressure Light, goes off within 10 seconds if proper voltage is being supplied to the ignition system. Any time the Light comes on while the Engine is running, this indicates that the Generator is not charging. At lower Engine speeds, the Light may come on briefly but go off when the Engine is speeded up. However, if the Light comes on at normal operating Engine speed, a malfunction is indicated. Call your Gravelly dealer.

**BRAKE PEDALS.** Stepping on the Brake Pedals actuates the front Wheel Brakes. The left Pedal actuates the left Wheel Brake; the right Pedal actuates the right Wheel Brake. The Pedals return to their normal position when foot pressure is released.

## attaching tools

All power attachments, plus certain non-power attachments, are secured to the front of the Tractor by four attachment bolts. All non-power attachments which trail the Tractor are secured to the Tractor by the optional Rear Hitch.

**FRONT-MOUNTED ATTACHMENTS.** To secure a front-mounted attachment, line up the four holes in the Attachment Drive Casting with the four holes in the Tractor Attachment Boss.

Tighten fully one of the top attachment bolts before tightening the other three. When removing the attachment, remove both bottom and one top attachment bolts before even loosening the remaining top attachment bolt.

## CAUTION

When securing or removing any attachment, or doing any work whatsoever to an attachment, be sure the Tractor Engine is stopped and the attachment is disengaged and not moving.



11

SEE  
FIGURE  
11

**REAR-MOUNTED ATTACHMENTS.** The Rear Hitch, available from your Gravely dealer, is required for all attachments which trail the Tractor. To attach the Rear Hitch:

1. Screw the Ball Stud into the Hitch Plate. Then screw the lock nut onto the Ball Stud.

SEE  
FIGURE  
12

2. Slip the Hitch Plate over the Rear Axle Pivot, lining up the holes in the plate with those in the Pivot.

3. Secure the Plate by inserting the bolt through the holes in the Plate and Pivot and tightening the lock nut firmly.

SEE  
FIGURE  
7

To secure an attachment to the Tractor :

1. Place the Split-Socket Connection around the Ball Stud.

SEE  
FIGURE  
12

2. Pull the attachment Drawbar over the Split-Socket Connection until the holes in the Drawbar coincide with those in the Connection.

3. Insert the Drawbar Pin through the holes.

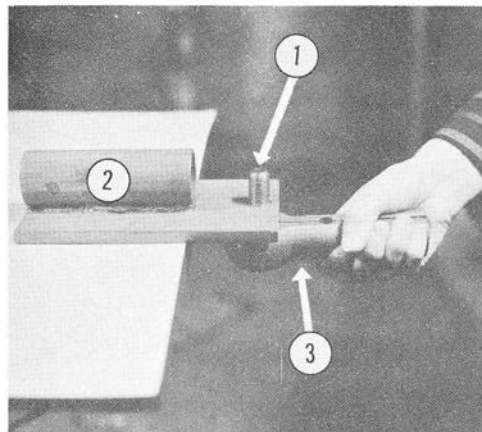

12

1. Ball Stud
2. Hitch Plate
3. Split-Socket Connection

## tractor operation

Before starting the Engine, always check to insure that the:

► High-Low Lever is in neutral (midway in its slot);

► Forward-Reverse Lever is in neutral (midway in its slot);

► Swiftamatic Lever is in the range in which you expect to operate;

► Attachment Clutch Lever is in the disengaged position (pulled fully to the rear); and

► Attachment Lift Lever is in the operating position (pulled fully to the rear).

**STARTING THE ENGINE.** Depress the Throttle Lever about one-third, depress the Choke Lever about one-half, and turn the Ignition Key clockwise as far as possible.

After the Engine starts, release the Key (it will return to the running position). Observe the Oil

Pressure and Generator Lights to insure that both go off within 10 seconds after the Engine has started. Return the Choke Lever to the running position.

In cold weather, it may be necessary to move the Choke Lever to the choke position. As the Engine warms up, gradually return the Choke Lever to the running position.

**ENGAGING TRACTOR WHEELS.** Have the Engine running at about one-third Throttle, and the Swiftamatic Lever in the range in which you expect to operate. See "Selecting Lever Settings", below.

Move the High-Low Lever to the desired position (slight spring resistance must be overcome to lock the Lever in position).

Then put the Tractor in motion



by locking the Forward-Reverse Lever in position (slight spring resistance must be overcome to lock this Lever in position, the same as on the High-Low Lever).

Note: The Forward-Reverse Lever is the key to putting the Tractor in motion. Of the three Levers (High-Low, Swiftamatic, and Forward-Reverse), it is the last to be engaged when starting, and the first to be disengaged when stopping.

As the Tractor begins to move, depress the Throttle Lever to the desired speed.

Note: The Engine is controlled by the Governor at all speeds.

ENGAGING POWER ATTACHMENT. Have the Tractor at a complete stop, with the Forward-

Reverse and High-Low Levers in neutral and the Engine idling. Be sure the attachment is in the operating position, with the Attachment Lift Lever pulled fully to the rear.

Push the Attachment Clutch Lever, the lower lever on the Steering Column, forward fully to engage the attachment.

Increase Engine speed to normal operating speed and engage the High-Low Lever. Check to insure that the Swiftamatic Lever is in high or low.

Then put the Tractor in motion by engaging the Forward-Reverse Lever.

DISENGAGING POWER ATTACHMENT. Simply pull the Attachment Clutch Lever fully to the rear to disengage the power at-

tachment. This can be done while the Tractor is moving or standing still.

**SHIFTING LEVERS.** We recommend the following procedures:

► Shift the High-Low Lever at any speed.

► Shift the Forward-Reverse Lever only when stopped or moving at slow speeds, thus preventing sudden braking action.

► Shift the Swiftamatic Lever only at a complete stop.

To shift the Swiftamatic Lever, first move the Forward-Reverse Lever to neutral. Then shift the Swiftamatic Lever. To insure full engagement of the Two Speed Axle, quickly move the Forward-Reverse Lever between its extreme positions one time and then lock it in forward or reverse.

**SELECTING LEVER SETTINGS.** As a general rule, easier jobs such as mowing a regularly-maintained lawn can be done with the Swiftamatic Lever in high range. The more difficult jobs, such as using the Snowblower in deep snows, generally are done best in the low Swiftamatic range.

The Swiftamatic Lever controls only the Two-Speed Axle, which regulates only Tractor ground speed. Within each Swiftamatic

## CAUTION

If you must shift the Swiftamatic Lever while working on a slope, come to a complete stop with the Tractor pointing across, rather than down, the slope.

range, the High-Low Lever can be shifted into high or low gear, adding a further ground speed control, as well as attachment drive speed control. The accompanying table (for illustrative purposes, values shown are approximate at Engine speed of 3400 RPM) shows the relationship between ground speed and attachment speed in the various Swiftamatic / High-Low Lever combinations.

Experience will dictate the proper combination of Swiftamatic and High-Low Lever settings to use. As a general rule, start your job in the fast ground speed setting (Swiftamatic and High-Low Levers in high). As long as the attachment can do the job properly, do not shift. But when ground speed becomes too fast for the attachment to do the job properly, shift to a lower setting.

#### LIFTING ATTACHMENTS.

Whenever a power attachment is to be lifted, always disengage the attachment and wait for it to stop moving before pushing the Attachment Lift Lever forward.

**BRAKES.** The Wheel Brakes can be used in several ways:

► Both Pedals can be pressed simultaneously to stop the Tractor. The Forward-Reverse Lever should be moved to neutral when

Swiftamatic Lever	High-Low Lever	Ground Speed	Attachment Drive Speed
Low	Low	1.8 MPH	1200 RPM
Low	High	2.4 MPH	1700 RPM
High	Low	3.6 MPH	1200 RPM
High	High	4.8 MPH	1700 RPM

stopping in this manner, similar to the way you would shift to neutral in an automobile with standard transmission.

► Single Wheel slippage can be overcome by gently braking the Wheel that is slipping. This transfers power automatically to the Wheel having traction.

► Should you want to negotiate a steep slope by working across it, instead of up and down it, you can obtain additional traction by shifting your body weight toward the up-hill side of the Tractor and applying slight braking action to the up-hill Wheel. Also, raising the power attachment slightly helps to improve traction on slopes.

**SECURING THE TRACTOR.**  
When through with a job, always secure the Tractor by stopping the

Engine and removing the Key. Have the attachment in the operating position, and disengaged. Return the Throttle Lever to the idle position, and the Choke Lever to the running position. By engaging the Forward-Reverse and High-Low Levers, the Tractor is locked in gear and thus will not move.

And if you're going to leave the Tractor outside, flip the Seat forward. Thus if a sudden shower occurs, the Seat will remain dry.

## **adjustments and repairs**

Your Tractor is a precision-manufactured machine, similar in many ways to your automobile. And just as you wouldn't attempt any major repairs to your car, the same holds true for your Tractor. Leave all major work up to your Gravelly dealer, who has the know-

ledge and parts, if required, to do this expertly and quickly.

However, there are certain minor procedures which most users can perform. These are outlined in the following.

## tires

Keep all four Tires inflated to a maximum pressure of 18 pounds.

### REPAIRING FRONT TIRE.

Should a front Tire be punctured, repair it as follows:

1. Engage the Forward-Reverse and High-Low Levers and place a block under the other front Wheel to keep the Tractor stationary.

2. Remove the Hub Cap, using a screwdriver or similar tool to pry it off.

3. Remove the Valve Core to insure that the Tube is fully deflated.

4. Loosen, but do not remove, the three hex-head cap screws in the Rim Assembly.

5. Jack the damaged Tire off the ground.

6. Remove the three previously-loosened cap screws to free the Tire and Rim Assembly from the Tractor.

7. Remove the three remaining screws in the Rim Assembly. This allows the Rim Assembly to be separated, exposing the Tube.

8. Repair the Tube with any high quality commercial patching material.

9. Reassemble the Rim Assembly before inflating the Tube.

SEE  
FIGURE  
13



### REPLACING FRONT TIRE.

When replacing a front Tire, the above procedures apply. Be sure, however, that the Tube is fully deflated before removing the Tire and Tube from the Rim Assembly.



13

14

REPAIRING REAR TIRE. To repair a punctured Rear Tire:

1. Follow Steps 1 and 2 under "Repairing Front Tire".

2. Jack the damaged Tire off the ground.

3. Remove the Axle Cap and nut to free the Wheel from the Tractor. Make sure the Bearing remains in place within the Wheel.

4. With the Tube fully deflated, break the bead between the Tire and Rim fully on both sides. Then pry the Tire over the Rim

SEE  
FIGURE

14

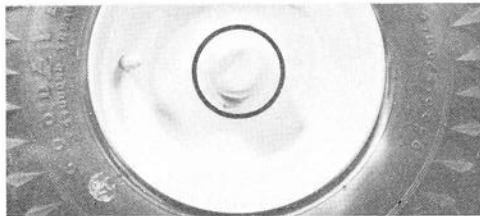

fully on the side where the Tire Valve protrudes.

5. Remove the Tube and repair with any high quality commercial patching materials.

CHANGING REAR TIRE. Follow generally the above procedures when replacing a rear Tire. Be sure the Tube is deflated fully.

# clutches

ADJUSTING HIGH-LOW CLUTCH. Need for adjustment of the High-Low Clutch is indicated by excessive slippage when the High-Low Lever is fully engaged.

To adjust for slippage felt in high gear:

1. With the Lever in neutral, loosen Lock Nuts 1.

2. Shift the Lever to high gear. Move Lock Nuts 1 upward until they compress the Clutch Rod Spring fully. Then tighten Lock Nuts 1 securely.

3. Return the Lever to neutral. Loosen Lock Nuts 4 and move them inward approximately the same number of turns as used for Lock Nuts 1. Then tighten Lock

Nuts 4 firmly.

To adjust for slippage felt in low gear:

1. With the Lever in neutral, loosen Lock Nuts 2.

2. Shift the Lever to low gear. Move Lock Nuts 2 upward until they compress the Clutch Rod Spring fully. Then tighten Lock Nuts 2 securely.

3. Return the Lever to neutral. Loosen Lock Nuts 3 and move them inward approximately the same number of turns as used for Lock Nuts 2. Then tighten Lock Nuts 3 firmly.

ADJUSTING FORWARD-REVERSE CLUTCH. Need for adjustment of the Forward-Reverse Clutch is indicated by excessive slippage when the Forward-Re-

SEE  
FIGURE  
15



verse Lever is fully engaged.

To adjust for slippage felt in forward:

1. With the Lever in neutral, loosen Lock Nuts 1.

2. Shift the Lever to high gear. Move Lock Nuts 1 upward until they compress the Clutch Rod Spring fully. Then tighten Lock Nuts 1 securely.

3. Return the Lever to neutral. Loosen Lock Nuts 4 and move them inward approximately the same number of turns as used for Lock Nuts 1. Then tighten Lock Nuts 4 firmly.

To adjust for slippage felt in reverse:

1. With the Lever in neutral, loosen Lock Nuts 2.

15

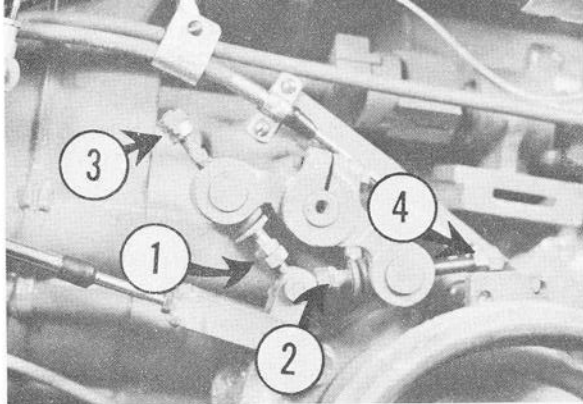

SEE  
FIGURE

16

16

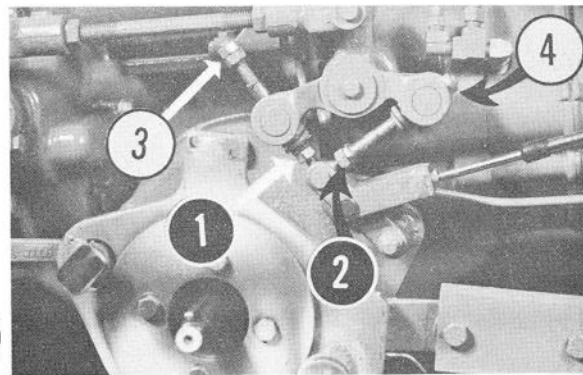

2. Shift the Lever to reverse. Move Lock Nuts 2 upward until they compress the Clutch Rod Spring fully. Then tighten Lock Nuts 2 securely.

3. Return the Lever to neutral. Loosen Lock Nuts 3 and move them inward approximately the same number of turns as used for Lock Nuts 2. Then tighten Lock Nuts 3 firmly.

## brakes

**BRAKES.** As normal wear takes place, the Brakes will require adjustment. Adjust them at the time the Pedals must be pushed all the way to the Floor-Board before braking action occurs.

To adjust, detach the Brake Rod from the Brake Lever by removing the cotter key and locking pin. Run the Brake Lever Fork back several turns and re-attach the

SEE  
FIGURE  
16

SEE  
FIGURE  
17

Rod. Continue until you have sufficient "pedal".

## belts

**GENERATOR BELT.** The two Generator Belts run between the Crankshaft and the Starter-Generator. When properly adjusted, moderate pressure applied to their mid-point deflects the Belt approximately one-half inch. To adjust Belt tension, the Starter-Generator is moved upward as follows:

1. Brake Rod
2. Brake Lever

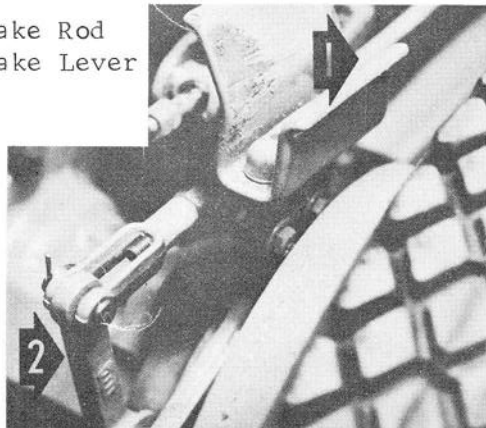

17

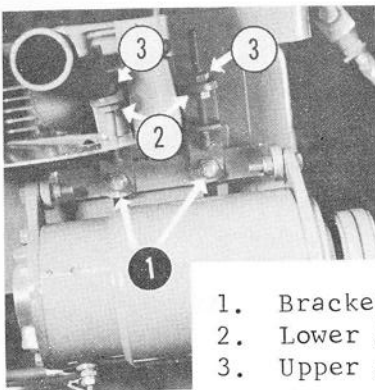

18

1. Bracket Nuts
2. Lower Adjustment Nuts
3. Upper Adjustment Nuts

1. Loosen the two Bracket Nuts. **SEE FIGURE 18**

2. Run the Lower Adjustment Nuts downward toward the Starter-Generator.

3. Raise the Starter-Generator by tightening the Upper Adjustment Nuts against the Adjustment Bracket. Tighten each the same number of turns, unless Starter-Generator cant must be

corrected to make the Belts run evenly in the Pulley.

4. After the Starter-Generator is positioned so that the Belts are in proper adjustment, lock the Lower Adjustment Nuts against the Adjustment Bracket.

To move the Starter-Generator down, reverse the above procedure with regard to the Upper and Lower Adjustment Nuts. This is usually required only when replacing the Belts. (Both Belts must be replaced at the same time.) In this case, move the Starter-Generator down far enough that the Belts may be replaced without having to pry them onto the Pulleys.

Note: Easier access to the left Upper and Lower Adjustment Nuts may be obtained by removing the Muffler.

**HYDRAULIC PUMP BELT.** To adjust the Hydraulic Pump Belt, which runs between the Crankshaft and Hydraulic Pump, the Hydraulic Pump is moved up or down until proper tension is reached (the Belt is in proper adjustment when moderate pressure applied at its mid-point will deflect it approximately one-half inch).

To adjust, loosen the Adjustment Nuts and move the Pump as required. Tighten the Adjustment Nuts when proper tension is reached.

**GOVERNOR BELT.** The Governor Belt runs between the Hydraulic Pump and the Governor. It is in proper adjustment when moderate pressure applied to its mid-point will deflect it approximately one-half inch.

SEE  
FIGURE  
19

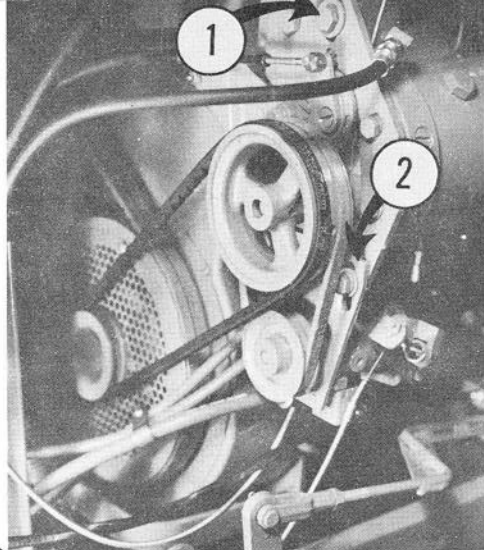

1. Pump Adjustment Nuts
2. Governor Adjustment Nuts

To adjust, loosen the Adjustment Nuts and move the Governor up or down as required.

**Note:** When adjusting, keep the Governor aligned as close to the Engine as possible.

OTHER. From time to time, other elements and systems of the Tractor may require repair or adjustment. We recommend that you have your Gravelly dealer perform this service work for you, especially with regard to the Carburetor, Distributor, Valves, and other parts where expert technical knowledge and special tools are required.

## storage

Although the Tractor has attachments that enable it to be employed year-round, if you do not plan to use it for several months--during the winter, for example--you should store it as follows:

1. Drain the Fuel Tank by unclamping the Fuel Hose from the Hose Connection.
2. Drain the Transmission

Case (see "Oil Changes"). Flush with kerosene. Refill with appropriate oil and run the Engine for two minutes to circulate the oil. Do not run over two minutes, as this will heat the Engine too much.

3. Remove the Battery and store where it cannot freeze.
4. Store the Tractor in a dry place. If possible, place blocks under the Tractor to keep the Tires off the floor.

When removing the Tractor from storage, fill the Tank with fresh gasoline, inflate the four Tires to a maximum pressure of 18 pounds, and change the Oil Filter, if required. Start the Engine in the usual manner. Do not be alarmed by heavy exhaust when the Engine is first started, this is merely excess oil being burned off, and will vanish within a few minutes of Engine operation.

## care of tractor body

The Tractor has a body made of fiber-reinforced plastic. This insures long body life, and maximum protection for the Tractor. The body will not rot, rust, or fade. Also, because the body material is so flexible, it is virtually impossible to dent the body. The Tractor runs quietly, too, due to the ability of fiber-reinforced plastic to absorb, not magnify, sound.

No special maintenance is required. Wash with a mild detergent or regular automotive-type detergent. If desired, standard automotive wax may be applied.

## tractor

### accessories

Shown in this section are accessories for the Tractor which are available from your Gravelly dealer.

---

**REAR HITCH.** The Rear Hitch is required for all attachments for the rear of the Tractor. Installation instructions are on Page 13.

**SEAT CUSHION.** Made of strong vinyl plastic, the Seat Cushion makes the Tractor's smooth riding qualities even smoother.

**TIRE CHAINS.** Easily installed, Tire Chains, of high-grade automotive quality, add traction for winter work on ice and snow.

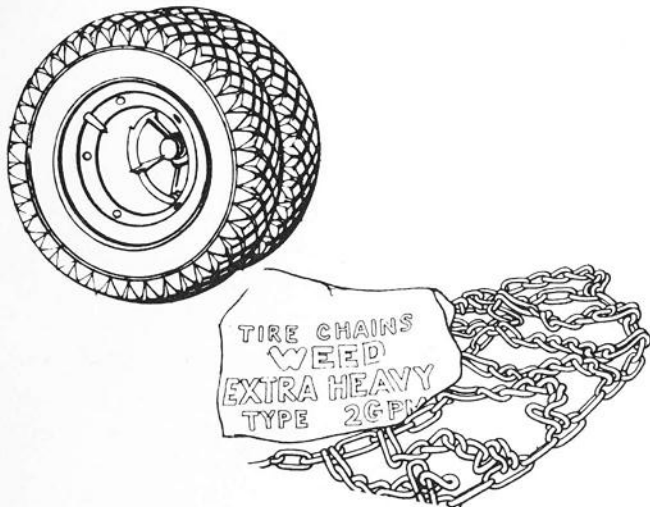

**DUAL WHEELS.** Dual Wheels are useful in situations where extra traction is required, such as for work on steep slopes and on snow and ice. To attach:

1. Run the Tractor Wheel onto a board approximately one inch thick.
2. Secure the Tractor by engaging the High-Low and For-

ward-Reverse Levers.

3. Remove the Hub Cap.
4. Remove the three hex-head cap screws which hold the Rim Assembly to the Tractor.
5. Place the Spacer against the Rim Assembly, with the small indentation in one of the recesses over the Tire Valve.
6. Insert the three long cap screws, provided with the Dual Wheels, through the holes in the Spacer recesses. Secure the Spacer to the Rim Assembly with these cap screws.
7. Attach the Dual Wheel to the Spacer using the three cap screws which were removed initially.
8. Replace the Hub Cap.



# power attachments

The following Gravely power attachments, adaptable for use with the Westchester Tractor, are covered in this section:

► 50-inch Rotary Mower (Page 31)

► 30-inch Reel Mower (Page 38)

► 25-inch Gang Reel Units (Page 43)

► 38-inch Power Brush (Page 46)

Other Gravely power attachments are being adapted for use with the Westchester, in particular the 32-inch Snowblower which will be available in the early fall of 1964.

Because of design similarities, it is possible to use several other Gravely power attachments---such as the 30-inch Rotary Mower, 42-inch Sickle Mower, and Rotary Plow---with the Westchester. We suggest you check with your Gravely dealer for details.

## CAUTION

Any time you adjust or do any work around an attachment, make sure the Tractor Engine is stopped and the attachment is disengaged and stopped.

## safety clutch

Each power attachment has a Safety Clutch which stalls the attachment when an obstacle is hit, preventing damage to both the Tractor and attachment.

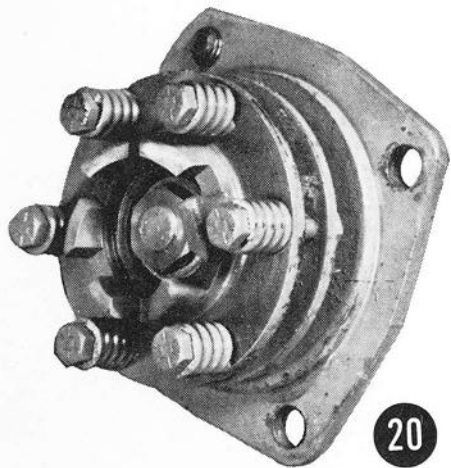

20

The Clutch is properly adjusted when there is a .025-inch gap between coils of the springs around the six bolts of the Clutch. Check the gap periodically with a feeler gauge.

To decrease the gap, tighten the bolts; to increase the gap, loosen the bolts. If excessive slippage is encountered after adjusting to .025-inch, decrease the gap to .020-inch.

SEE  
FIGURE  
20

## 50-inch rotary mower

The 50-inch Rotary Mower is designed for fast, efficient mowing of large lawns. Unique swivel action permits the Mower to follow ground contours, insuring a uniform cut through its wide 50-inch swath.

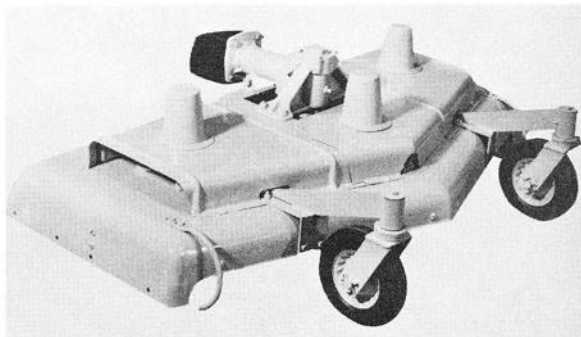

**ATTACHING TO TRACTOR.**  
The Mower is attached to the front of the Tractor by the four Attachment Bolts, as explained on Page 13.

**LUBRICATION.** Check the Gear Housing oil level every four hours of operation, by removing the Oil Level Plug. If oil runs out, the oil level is all right; if not, oil must be added.

To add oil, remove the Oil Filler Plug. Pour until the oil begins to run out the Oil Level Hole. Replace both Plugs before mowing.

Use Mobilube EP-140 (SAE 140) in the Gear Housing.

Use Mobilgrease MP every 10 hours in the grease fittings on the Caster Brackets and Swivel Casting.

Use Mobilgrease MP every 10 hours in the grease fitting on each Spindle Assembly.

Note: These grease fittings are

vented to make over-lubrication impossible. If grease begins to run out the vent, this means lubrication capacity has been reached.

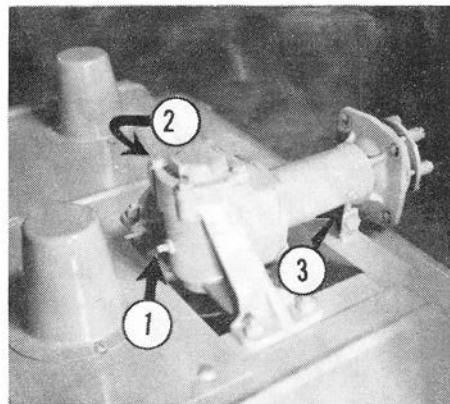

SEE  
FIGURE  
21

21

1. Oil Level Plug
2. Oil Filler Plug  
(approximate location)
3. Swivel Casting  
grease fitting

**CUTTING HEIGHT ADJUSTMENT.** Cutting height adjustment is made at the Spindle Assemblies on the Spindle Shafts.

Each of the three Blades can be adjusted to cut from one to four inches from the ground. At delivery, the cutting height is set at 2 1/2 inches from the ground. To adjust each Blade:

1. Detach the Spindle Cover by removing the screws which hold it to the Deck.

2. Remove the cotter key from the end of the Height Adjustment Pin. On the center and right Blades the cotter key and Pin are accessible upon removal of the Spindle Covers. However, to gain access to the left Blade cotter key and Pin, reach under the left Belt Guard. An alternate method is to remove the entire left Belt Guard (which includes the Spindle Cover) by removing screws which hold it to the Deck.

3. Insert a screwdriver or

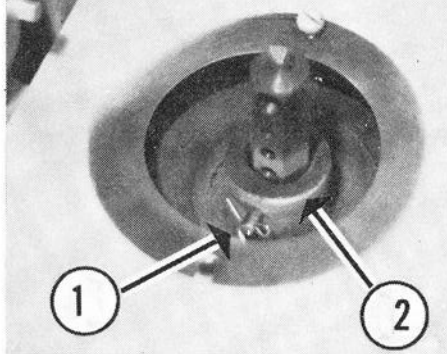

22

1. Height Adjustment Pin
2. Shaft Housing

SEE  
FIGURE  
22

similar tool in the large hole at the top of the Spindle Shaft. Using the screwdriver, lift up slightly on the Shaft and remove the Pin.

4. There are six holes in the Shaft (exclusive of the large hole in which the screwdriver was placed) which regulate the cutting height. The topmost hole sets the cutting height at 1 1/2 inches from the ground, the next at two inches from the ground, and so on in 1/2-

inch increments to a maximum cutting height of four inches. Line up the hole corresponding to the desired cutting height with the holes in the Shaft Housing and insert the Height Adjustment Pin. Then insert the cotter key in the end of the Pin.

5. Replace the Spindle Covers (and the left Belt Guard, if it has been removed).

**CUTTING PLANE ADJUSTMENT.** The Caster Wheels keep the Mower in a horizontal plane parallel to the ground. When the Caster Wheels are adjusted properly and the three Blades are set at the same cutting height, the Mower cuts smoothly and uniformly throughout its swath.

During operation, should you notice the Mower cutting closer on one side of its swath than on the other, or if the Skids leave a nar-

SEE  
FIGURE  
22

row trench-like depression, the Caster Wheels are out of adjustment.

Adjust with the four large washers on the Caster Bracket. To raise the Mower, place two, three, or four washers at the bottom of the Bracket; conversely, to lower the Mower, place two, three, or all four washers at the top of the Bracket. If one Skid marks the lawn, raise the Mower by the Caster Wheel nearer it; if both Skids mark the lawn, raise the Mower by both Caster Wheels.

To rearrange the washer combination, place a block under the Skid nearer the Caster with which you are working. Then remove the bolt which secures the Caster Fork to the Caster Bracket. Remove the Caster Wheel and Fork and rearrange the washers as desired. Then reassemble the entire Caster Assembly.

**BELTS.** The Mower has two Belts: the right Belt, which drives the center and right Blades, and the left Belt, driving only the left Blade.

**BELT ADJUSTMENT.** Proper Belt adjustment is vital. If too tight, the Belts will wear excessively. If too loose, the Belts will slip, causing the Mower to miss

areas. Also, improper adjustment causes the Belts and Bearings to run hotter than they should.

The left Belt is adjusted at the left Spindle Assembly, access to which is gained by unscrewing the left Belt Guard from the Deck. The right Belt can be adjusted at either the right or center Spindle Assembly, access to which is

▶ SEE  
FIGURE  
23

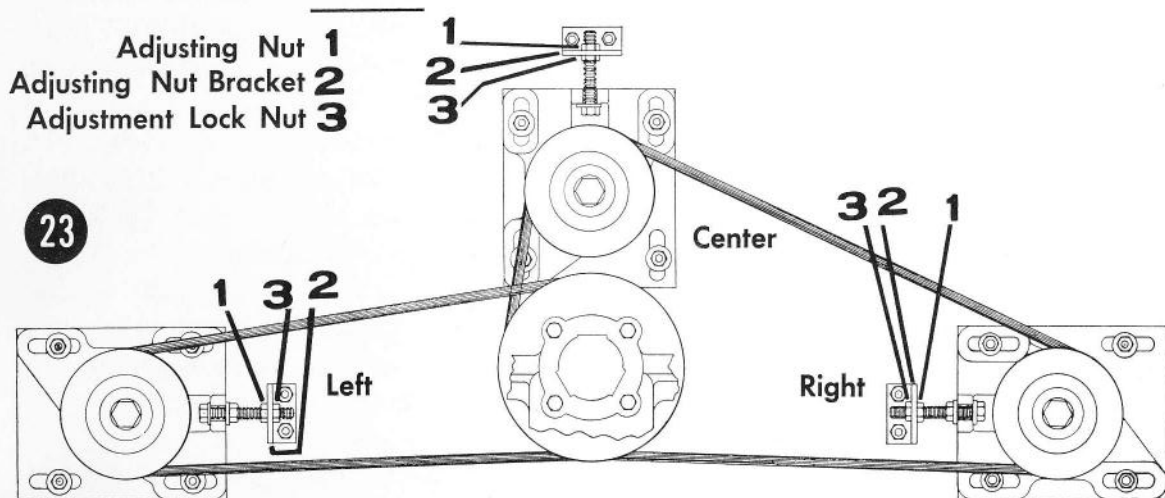

gained by unscrewing the center and right Belt Guards. Adjust the right Belt at the right Spindle Assembly initially; if additional adjustment is needed do this at the center Spindle Assembly.

Note: In adjusting the Belts it is possible to pull a Spindle Assembly far enough from its proper position to cause its Blade to strike the adjacent Blade while mowing. When you have adjusted the Belts, always rotate the Blades by hand to make sure there is no Blade interference and to insure there is sufficient overlap to keep from missing areas, especially on turns.

The procedure for tightening each Belt is the Same: the Spindle Assembly is moved from the Main Drive Pulley as follows:

SEE  
FIGURE  
23

1. Loosen the four nuts which hold the Spindle Assembly and Dust Shield to the Deck.

2. Back off the Adjustment Lock Nut several turns from the Adjusting Nut Bracket.

3. Tighten the Adjusting Nut against the Adjusting Bracket until proper Belt tension is reached. When properly adjusted, moderate pressure at the Belt's midpoint will deflect it approximately one-half inch.

4. Holding the Adjusting Nut against the Adjusting Nut Bracket, tighten the Adjustment Lock Nut against the Bracket.

5. Tighten firmly the four nuts which hold the Spindle Assembly and Dust Shield to the Deck.

In loosening a Belt, the Spindle Assembly is moved toward the



Main Drive Pulley as follows :

1. Loosen the four nuts securing the Spindle Assembly and Dust Shield.

2. Back off the Adjusting Nut several turns from the Adjusting Nut Bracket.

3. Back off the Adjustment Lock Nut from the Adjusting Nut Bracket until proper Belt tension is reached.

4. Holding the Adjustment Lock Nut firmly against the Adjusting Nut Bracket, tighten the Adjusting Nut firmly against the Bracket.

5. Tighten firmly the four bolts securing the Spindle Assembly and Dust Shield to the Deck.

**BELT REPLACEMENT.** After all possible Belt adjustment has

been made, if the Mower continues to skip over areas within its swath, replacement of the appropriate Belt is indicated.

We recommend you have your Gravely dealer replace the Belts. But if you want to do this yourself, ask your dealer for a free copy of the Gravely Instruction Manual, in which directions are printed.

SEE  
FIGURE  
23

**BLADE SHARPENING.** To sharpen a Blade, remove it from the Mower and use the original cutting edges as your guide. After sharpening, test for proper balance by inserting a screwdriver and holding the screwdriver parallel to the ground. If one side of the Blade dips noticeably, that side is too heavy and should be ground further.

**OPERATION.** We recommend that you mow so the cut grass is discharged (out the left side of the Mower) onto the lawn areas which have not been cut.

## **CAUTION**

Never put your hands or feet under the Deck while the Mower is running, or for an interval after the Mower has been disengaged. Make sure all Blades are stopped before attempting any repair or adjustment to the Mower.

## **30-inch reel mower**

The 30-inch Reel Mower gives a smooth and uniform cut every time. For larger mowing jobs, a 25-inch Gang Unit may be attached to each side to provide a 75-inch swath.

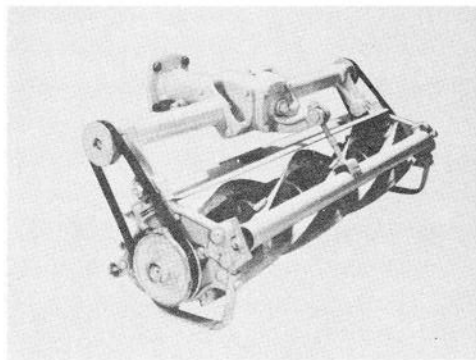

**ATTACHING TO TRACTOR.** The Mower is attached to the front of the Tractor by the four Attachment Bolts, as explained on Page 13.

**LUBRICATION.** Check the Gear Housing oil level every four hours of operation by removing the Oil Level Plug. If oil runs out, the oil level is all right; if not, oil must be added.

SEE  
FIGURE  
24

To add oil, remove the Oil Filler Plug, and pour until oil begins

to run out the Oil Level Hole (too much oil will cause over-heating and consequent gear damage). Replace both Plugs before mowing.

Mobilube EP-140 (SAE 140) is recommended.

Change oil in the Gear Housing at least annually. To drain, remove the entire Strut Casting; replace after the oil has drained. Add oil as explained previously.

Use Mobilgrease MP occasionally in the Swivel Casting grease fitting, and as required in the grease fittings for the Reel Bearings. It is important to lubricate properly the Reel Bearings, as the grease forms a water seal around each Bearing, preventing rust. Use Mobilgrease MP as required in the Roller Bar grease fittings.

SEE  
FIGURES

24

25

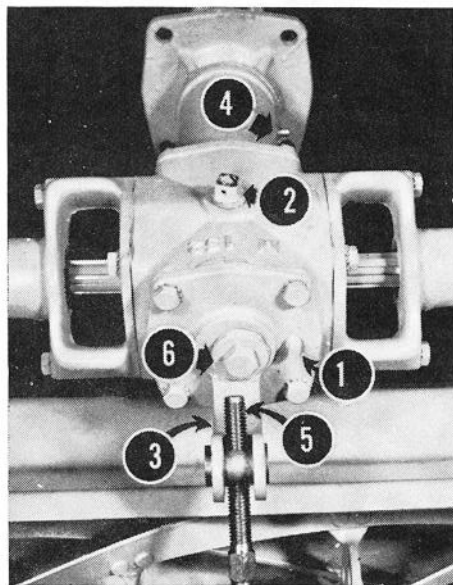

24

1. Oil Level Plug
2. Oil Filler Plug
3. Strut Casting
4. Swivel Casting grease fitting
5. Height Adjustment Screw
6. Reverse Bolt

**CUTTING HEIGHT ADJUSTMENT.** Turn the Height Adjusting Screw clockwise to raise the cutting height; turn it counter-clockwise to lower the cutting height.

**REVERSE LAPPING OF REEL.** The Mower has a special reverse which permits lapping the Reel against the Bed Knife, eliminating in some cases grinding the Reel. The Reel should be lapped any time the adjustment of the Reel against the Bed Knife is changed radically. To lap the Reel:

1. Loosen the bolt on the front of the Gear Housing.
2. Slowly roll the Reel back and forth with one hand, pushing the bolt to the opposite side of the Gear Housing with the other. This engages the reverse; when fully engaged, tighten the bolt.
3. With the Mower running at

SEE  
FIGURE  
24

25



normal speed, carefully use a paint brush to apply a 60-grit lapping compound to the Reel. Allow the Reel to lap in reverse until it makes good contact with the Bed Knife Bar along its entire length.

To put the Reel back into forward, use the above procedure, except push the bolt to the right and lock by tightening.

**REEL ADJUSTMENT.** The Reel must be adjusted properly for the Mower to do a good job.

To test Reel adjustment, place a sheet of paper between the Reel and Bed Knife Bar and turn the Reel by hand. Perform this test at several points along the Bar.

If the paper is cut cleanly each time, the Reel is in proper adjustment. If not, the adjustment is too loose and must be corrected by moving the Reel closer to the Bed Knife Bar.

Note: If the Reel contacts the Bar (this will seldom occur), the adjustment is too tight and must be corrected by moving the Reel away from the Bar.

The Reel is adjusted by the Adjustment Lock Nut and the Reel Adjusting Bolt. To move the Reel

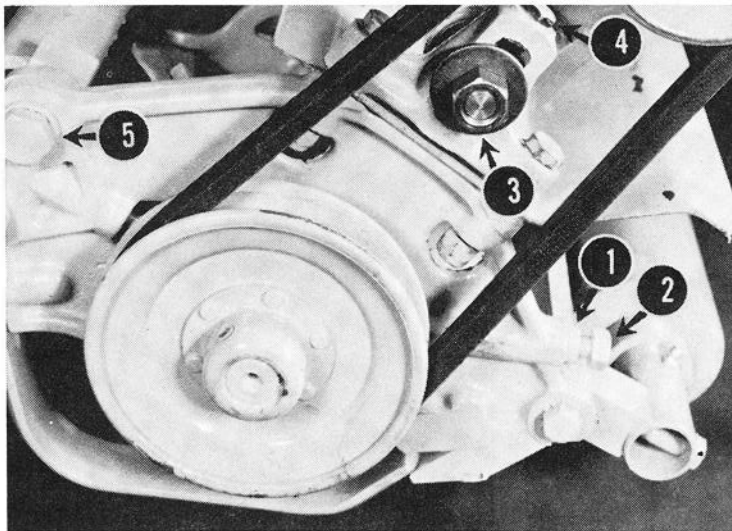

26

SEE  
FIGURE

26

1. Adjustment Lock Nut
2. Reel Adjusting Bolt
3. Belt Adjusting Nut
4. Belt Adjusting Bolt
5. Tie Rod Bolt

closer to the Bar, loosen the Adjustment Lock Nut and turn the Reel Adjusting Bolt counter-clockwise, to move it from the Bar, turn the Reel Adjusting Bolt clockwise.

Adjustment can be made at either side of the Reel. If, for example, facing the Reel you find the paper is not cut cleanly on the right side, loosen the Adjustment Lock Nut on the right side and turn the Reel Adjusting Bolt counter-clockwise. Then loosen the Adjustment Lock Nut on the left side and turn the left Reel Adjusting Bolt clockwise slightly. Test. Repeat if necessary. Tighten the Adjustment Lock Nuts to hold the adjustment.

**BELTS.** Power is transmitted from the Gear Housing to the Reel by means of a V-Belt at each end of the Reel.

**ADJUSTMENT.** Both Belts are in proper adjustment when moderate pressure applied to the midpoint of each Belt will deflect it approximately one inch.



**SEE  
FIGURE  
26**

To tighten a Belt, loosen the Belt Adjusting Nut and turn it clockwise. To loosen, turn the Adjusting Bolt counter-clockwise. After proper adjustment is reached tighten the Adjusting Nut.

If the Adjusting Bolt has been turned clockwise as far as possible and the Belt does not tighten, the Belt should be replaced.

**INSTALLATION.** To install a new Belt, turn the Height Adjusting Screw until it releases the Reel Assembly from the Gear Housing Strut. Raise the Mower slightly and swing the Reel toward the Tractor until the Belts are loose on the Pulleys. Remove the old Belt and replace with the new one. With the new Belt in place, return the Reel Assembly to the normal position, replace the Height Adjusting Screw, and adjust the Mower to the proper cutting height.

## 25-inch gang units

The first step in attaching each 25-inch Gang Unit to the 30-inch Reel Mower is to attach the Power Take-off to the Swivel Casting (of the Drive Assembly).

Next, a Belt for each Gang Unit must be attached to the Power Take-off as follows:

1. Remove the Belts from the 30-inch Reel Mower. See "Installation", Page 42.

2. Loosen the set screws and remove the Outer Drive Pulley.

3. Loosen the Bearing Cap Screw. Pull the Outer Cross Shaft out as far as possible so there is room to insert the Inner Wing Drive Pulley and Belt into the opening.

SEE  
FIGURES

26

27

28

29

Belt Adjusting Screw

27

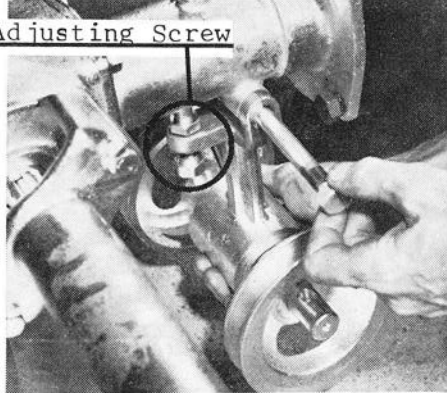

4. Replace the Outer Cross Shaft, engaging it with the Inner Drive Pulley and tightening the set screw on this Pulley. Replace all parts.

Next, attach the Leader as follows:

1. Remove the top Tie Rod Bolt replacing it with the Leader Pivot and Stud.

2. Attach the Leader Swivel to the Leader Pivot by using the

Leader Swivel Pin. On new equipment, the Leader Swivel Pin may not fit easily because of paint on the Pin and inside the holes into which it fits. Use fine emery paper to remove the paint.

Finally, attach the Universal Assembly as follows:

1. Place the Wing Spider in position against the Reel Bearing. Tighten the set screws.

2. Grasp the Locking Ring (pulling back against its spring), and place it against the Lower Take-off Shaft, lining up the Locking Ring balls with the holes in the Shaft.

3. Release the Locking Ring to lock the Universal Assembly securely in position against the Power Take-off.

SEE  
FIGURES

27

30

ADJUSTMENTS AND LUBRICATION. With the following exceptions, all adjustments and lubrication of the Gang Units are the same as for the 30-inch Reel Mower:

**BELTS.** Belt tension is adjusted by the Belt Adjusting Screw and Lock Nut. To increase tension, loosen the Lock Nut and turn the Adjusting Screw clockwise; to decrease tension, turn the Adjusting Screw counter-clockwise. When proper tension is reached (proper adjustment is when moderate pressure applied to the mid-point of the Belt will deflect it approximately one inch) tighten the Lock Nut.

**LEADERS.** For best results adjust the Leaders so the Gang Units will run parallel with the 30-inch Reel Mower.



**CUTTING HEIGHT.** To adjust the cutting height, loosen the Lock Nut and turn the Height Adjusting Screw clockwise (to increase cutting height) or counter-clockwise (to lower cutting height). Tighten when proper adjustment is reached.

SEE  
FIGURE

29

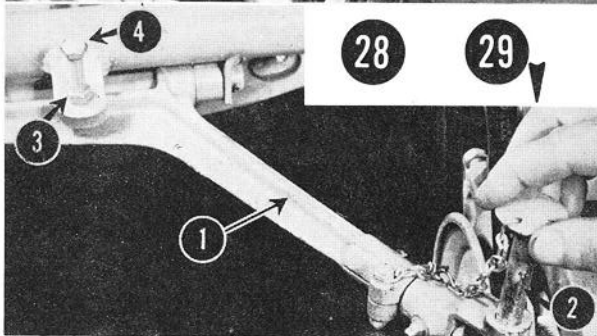
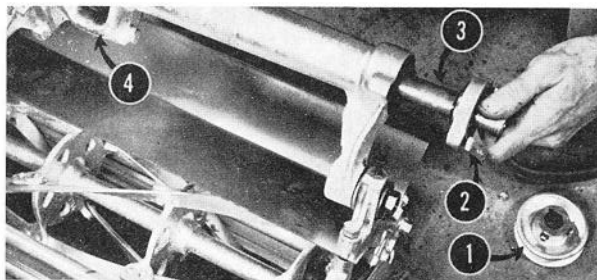

28

1. Outer Drive Pulley
2. Bearing Cap Screw
3. Outer Cross Shaft
4. Opening

29

1. Leader
2. Leader Swivel Pin
3. Lock Nut
4. Height Adjusting Screw

30

1. Universal Assembly
2. Wing Spider
3. Locking Ring

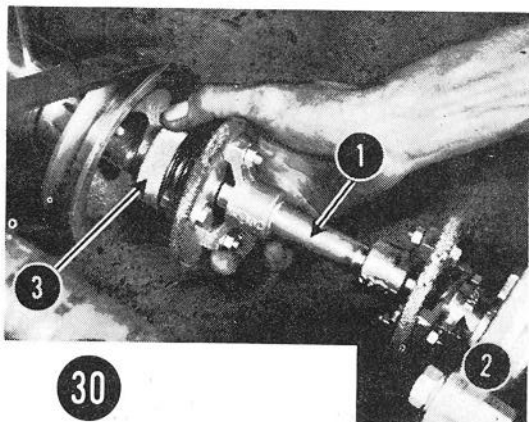

## 38-inch power brush

The Power Brush is a useful tool for cleaning drives, sidewalks, and other areas where power sweeping is necessary. The Brush can be used for sweeping light snows--up to six inches in depth--clean to the pavement unless there is an ice skim on the pavement.

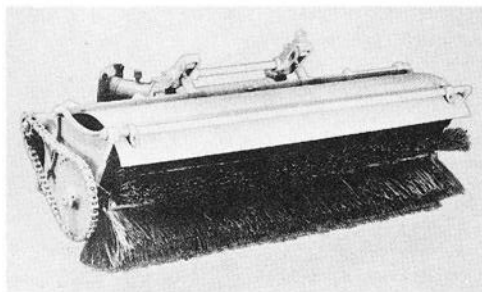

### ATTACHING TO TRACTOR.

The Power Brush is attached to the front of the Tractor by the four Attachment Bolts, as explained on

Page 13.

**LUBRICATION.** Check the Drive Assembly oil level every eight hours of operation by removing the Oil Filler Plug and observing whether the gears dip halfway in the oil.

SEE  
FIGURE  
31

Add oil, if necessary, through the Oil Filler Hole. Use Mobilube EP-140 (SAE 140).

Be sure the Tractor and Brush are level when checking or adding oil.

Use Mobilgrease MP in the grease fitting (or grease cup) on the Drive Assembly (this is close to the point where the Drive Assembly is attached to the Tractor).

**ADJUSTMENTS.** To adjust the Chains, simply remove a half link

when the Chain has been driving long enough to "stretch". This usually occurs after several months of use.

To adjust Brush contact, put the Brush in contact with the ground by lifting up on the Brush Contact Lever. Then turn the Brush Tension Adjusting Bolts until proper tension is reached.

Proper Brush tension must be learned by experience. The Brush must be placed under sufficient pressure to enable it to sweep clean. Always adjust Brush tension downward until correct tension is obtained.

Note: Too much pressure will cause the Brush Strips to wear out prematurely.

REVERSING OR CHANGING BRUSH STRIPS. When it appears

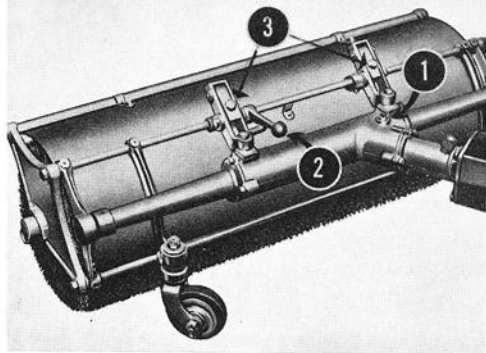

31

1. Oil Filler Plug
2. Brush Contact Lever
3. Brush Tension Adjusting Bolts

SEE  
FIGURE  
31

the Brush Strips have worn more on one side than on the other, it is time to reverse the Strips in the Brush Spiders. To do this, loosen the bolts which hold the Strips in the Spiders and remove the Strips. Then reverse the Strips (or replace, when necessary, with new Strips obtained from your Gravelly dealer) and tighten the bolts. Adjust to proper tension following procedures outlined above.

# non-power attachments

## 48-inch snowplow

The 48-inch Snowplow clears the average walkway in one pass, the average driveway in two. It moves snow as deep as 18 inches. Key to its efficiency is its unique design--instead of pushing the snow, the Snowplow rolls it out of the way.

### ATTACHING TO TRACTOR.

The Snowplow is attached to the front of the Tractor by the four Attachment Bolts.

**LUBRICATION.** No lubrication is required.

**ADJUSTMENTS.** The Snowplow can be set to roll snow straight ahead or to the left or right. It can

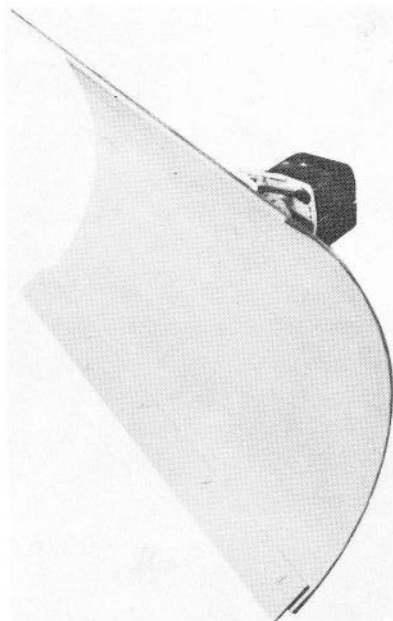

be adjusted to permit the Blade to follow ground contour (swivel action) or it can be set so the Blade is held rigidly.

To set the Snowplow to roll straight ahead with swivel action,

line up the center hole in the Swivel Bracket with the center hole in the Swivel Casting and insert the T-shaped Adjusting Pin. To hold the Blade rigidly in the straight-ahead position, insert the Pin in either side hole.

To roll snow to the left with swivel action, line up the left hole in the Swivel Bracket with the center hole in the Swivel Casting and insert the Pin. To hold the Blade rigidly in the left position, insert the Pin in the holes immediately to the right.

To roll snow to the right with swivel action, line up the right hole in the Swivel Bracket with the center hole in the Swivel Casting and insert the Pin. To hold the Blade rigidly in the right position, insert the Pin in the holes immediately to the left.

**WEARING STRIP.** The Wearing Strip on the bottom of the Blade eventually will have to be replaced. To replace, simply remove the screws, take off the old Strip, put the new Strip on, and tighten the screws firmly.

**SKIDS.** Skids, available from your Gravely dealer, are useful when working on concrete drives where one side is higher than the other and on gravel or bluestone drives.

To attach the Skids, remove the end screws from the Wearing Strip and insert the long bolts provided with the Skids. Slip the Skids onto the bolts from the rear of the Blade, with the long sides down and parallel to the ground. Fasten the nuts securely on the bolts.

**RECOMMENDED ACCESSORIES.** Tire Chains are helpful when removing snow from ice-coated pavements.

## **lawn roller**

The Lawn Roller makes easy the job of smoothing out rough places on lawns. It is 32 inches wide, has round edges to prevent lawn damage, and weighs 655 pounds when filled to capacity with water.

**ATTACHING TO TRACTOR.**  
The Rear Hitch is required.

**LUBRICATION.** An occasional greasing of the Axles with Mobil-grease MP is the only lubrication required. To lubricate, remove the cotter pin and slip off the large washer. Make sure both are replaced.

**FILLING THE ROLLER.** Move Roller until the Filler Plug (a large brass plug on the right side of the Roller) is at its highest point. Simply remove the Plug to

fill the Roller; be sure it is replaced after filling. Water generally is used.

## **5-foot seeder-spreader**

The 5-foot Seeder-Spreader is useful for seeding large lawn areas, as well as for spreading fertilizer. Its 300-pound capacity and extra width make it ideal for these uses.

**ATTACHING TO TRACTOR.**  
The Rear Hitch is required.

**LUBRICATION.** Use Mobil-grease MP occasionally in the grease fitting on each Wheel.

**DISTRIBUTION CONTROLS.**  
To determine the proper distribu-

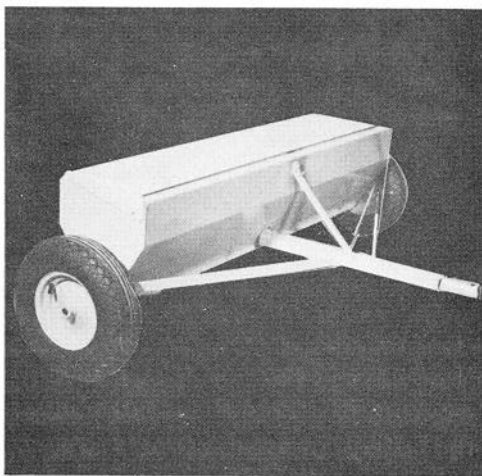

tion of seed or fertilizer, refer to the self-explanatory plate attached to the Hopper. Simply set the Port Lever to the indicated opening.

**CARE OF HOPPER ASSEMBLY.** Many materials used in the Seeder-Spreader, especially certain fertilizers, are corrosive. Abrasives also are present. This

means the protective paint soon will wear off the Port Assembly and Agitator. To protect these surfaces, wash thoroughly with water after each use and let it dry, preferably in the sun. If you do not intend to use it again within a few days, pour a small quantity of Mobiloil along the Port openings and work the Port Lever back and forth to distribute the oil.

## hauling cart

There's always hauling to be done--and with the Hauling Cart you have a rugged, dependable vehicle which can handle a 1,000-pound load.

Cart sides are removable, and stakes can be substituted for hauling bulky loads. Pneumatic Tires are standard equipment.

#### ATTACHING TO TRACTOR.

The Rear Hitch is required.

LUBRICATION. The only lubrication required is an occasional shot of Mobilgrease MP in the

grease fittings on the Wheels.

DUMPING. The Cart is dumped by releasing the Latch (which holds the Body to the Frame) and tilting the Body to the rear.

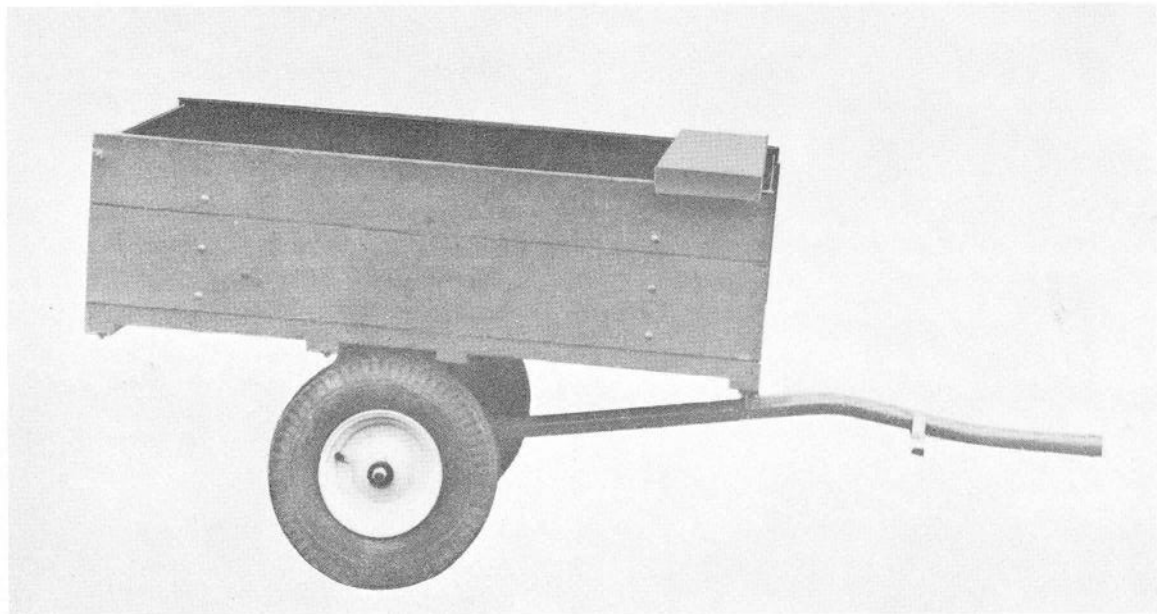



# owner's equipment record

Tractor Serial Number \_\_\_\_\_ Tractor Manufacturing Number \_\_\_\_\_

Identifying Marks Other Than Above \_\_\_\_\_

Purchased From \_\_\_\_\_

Gravely Representative's Telephone Number \_\_\_\_\_

## EQUIPMENT LIST

Description	Model Number	Description	Model Number
-------------	--------------	-------------	--------------

_____	_____	_____	_____
-------	-------	-------	-------

_____	_____	_____	_____
-------	-------	-------	-------



Printed in U.S.A. 4/64 4M